

850nm 4W VCSEL Diode VP-0850P-004W-1C-1AX

Features

- Single wavelength
- Low wavelength drift
- Oxide isolation technology
- Low threshold current
- High reliability
- Easy to collimate

Applications

- 3D sensors
- Lidars
- IR illuminations
- Medical applications
- Proximity sensors
- Military applications

PRODUCT IDENTIFY

Part Number	Description
VP-0850P-004W-1C-1AX	850nm 4W VCSEL+ Photo diode + diffuser

CODE RULES

e.g. VP-0850P - 004W - 1C - 1 A X

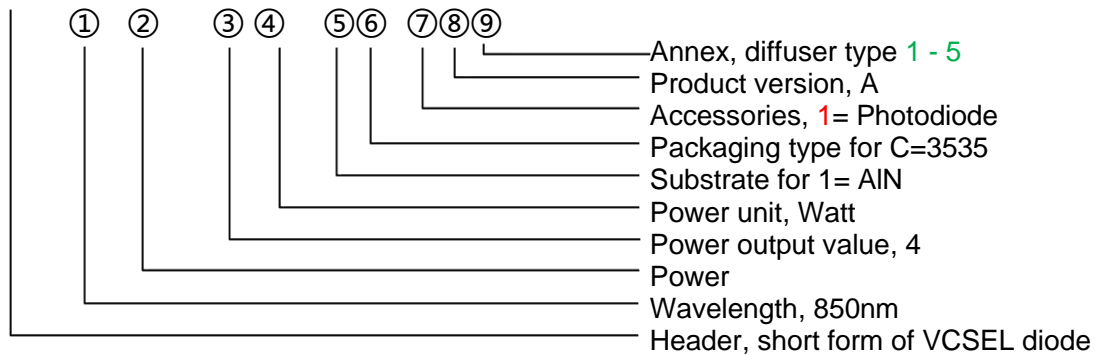

Part ⑨ (Diffuser beam angle) Option to choose specific diffuser types

Part number	Diffuser types	Description (Horizontal x Vertical)
VP-0850P-004W-1C-1A(X)		
VP-0850P-004W-1C-1A <u>1</u>	6045	60°x 45 °
VP-0850P-004W-1C-1A <u>2</u>	7258	72°x 58 °
VP-0850P-004W-1C-1A <u>3</u>	9070	90°x 70 °
VP-0850P-004W-1C-1A <u>4</u>	B085	110°x 85 °
VP-0850P-004W-1C-1A <u>5</u>	C090	120°x 90 °

Photodiode	Range	filter	substrate	responsivity
1	400-1100 nm	no	Si	0.97@850nm
2	870-970nm	yes	Si	0.9@940nm

I . Absolute maximum ratings

Parameter	Symbol	Rating	Unit
Case Operating Temp	Top	-40 to 85	°C
Storage Temp	Tsto	-40 to 105	°C
Reflow Soldering Temperature	Tsdr	260°C(10s)	°C
Reverse Voltage	Vr	5	V

Maximum Continuous Current	I _{max}	5	A
ESD exposure (Human body) model	ESD	2K	V

Note:

1. Stresses greater than those listed under “Absolute Maximum Ratings” may cause permanent damage to the device. This is a stress rating only and functional operation of the device at these or other conditions above those indicated in the operations section for extended periods of time may affect reliability.
2. In its maximum rating diode laser operation could damage its performance or cause potential safety hazard such as equipment failure.
3. Electrostatic discharge is the main reason for the laser fault of the diode. Take effective precautions against ESD. When dealing with laser diodes, use the wrist strap, grounding work surface and strict antistatic technology.

II. Optical-electrical characteristics @25°C

Parameters	Conditions	Symbol	Unit	Min.	Typ.	Max.
Optical Power	I _F =4.5A	P _o	W	-	4	-
Threshold Current	-	I _{th}	A	-	0.6	-
Forward Current	-	I _F	A	-	4.5	-
Power conversion efficiency	I _F =4.5A	η	%	36	38	41
Slope efficiency	P _o =4 W	-	W/A	-	1.03	-
Peak Wavelength	I _F =4.5A	-	nm	840	850	860
Laser Forward Voltage	I _F =4.5A	V _f	V	2.1	2.3	2.4
Series Resistance	I _F =4.5A	R	Ω	0.50	0.52	0.54
Original Beam Angle	I _F =4.5A	-	Degrees	-	20	25
Wavelength Temp. drift	I _F =4.5A	-	nm/°C	-	0.07	-
Emission area	-	-	um	-	1070x1034	-
Rise/Fall time	-	-	ns	-	1	-
Soldering Temperature	-	-	°C	-	-	260(10s)
Substrate	AlN					

Note: Electro-Optical Characteristic with a package or diffuser would require further evaluation. Values are based on limited sample size and estimated values.

III. Environmental Specifications

Parameter	Symbol	Min.	Typ.	Max.	Units	Ref.
Case Operating Temp	T _{op}	-40	25	85	°C	-
Storage Temp	T _{sto}	-40	25	105	°C	-

IV. LIV Graph and Wavelength

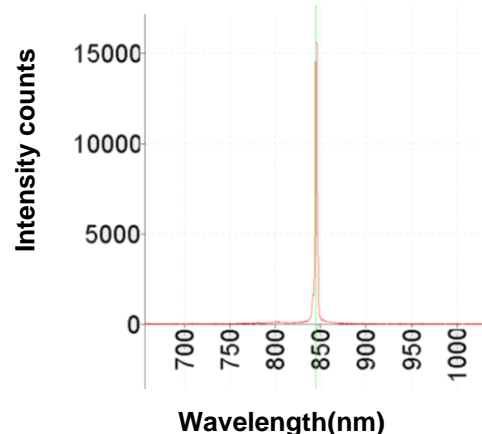
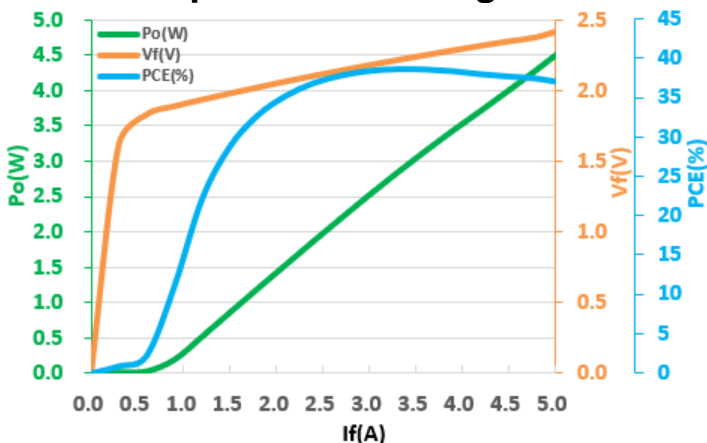

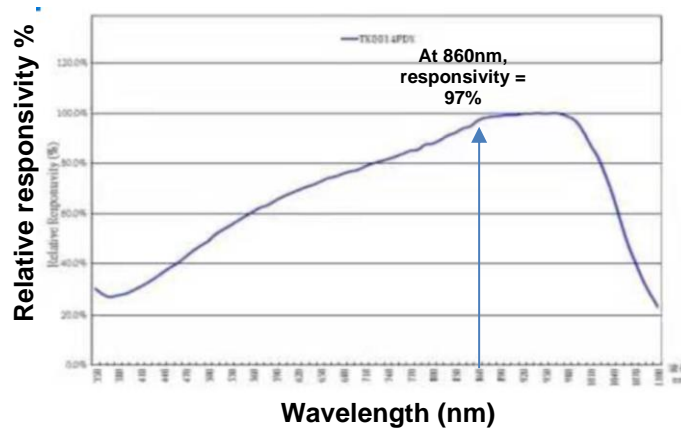

V. Mechanical Schematics

VP-0850P-004W-1C-1AX (substrate AlN, 3535 packaging), unit:mm

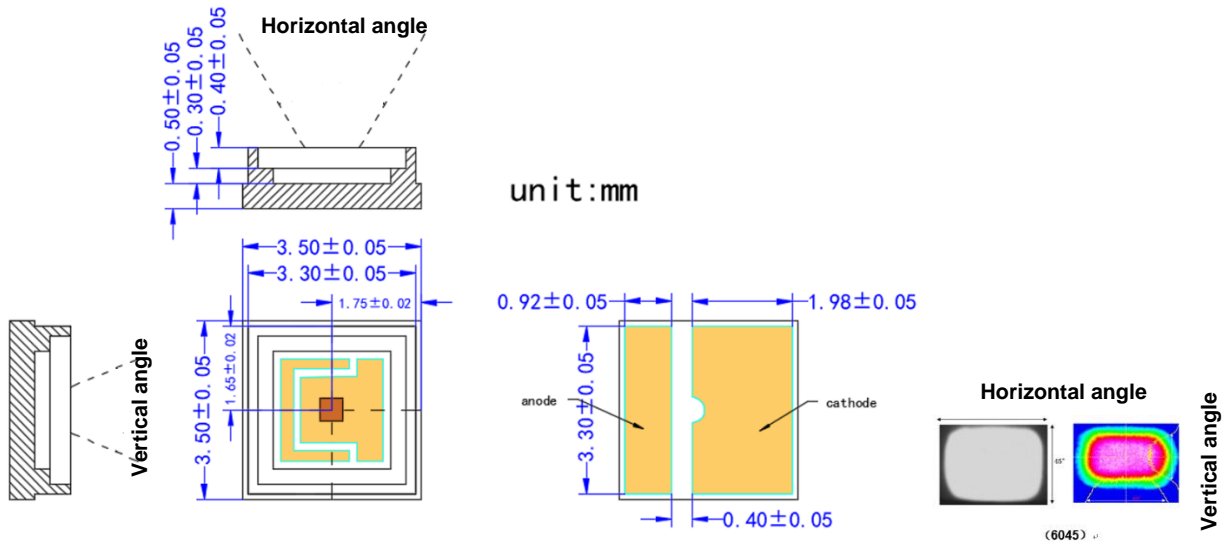

Note: The green arrow represents the direction of the diffuser. There may be some changes between sample and drawing, thus, the actual spec please refer to the sample that you received. And if any question please contact us.

VI. Typical laser spot & Beam profile

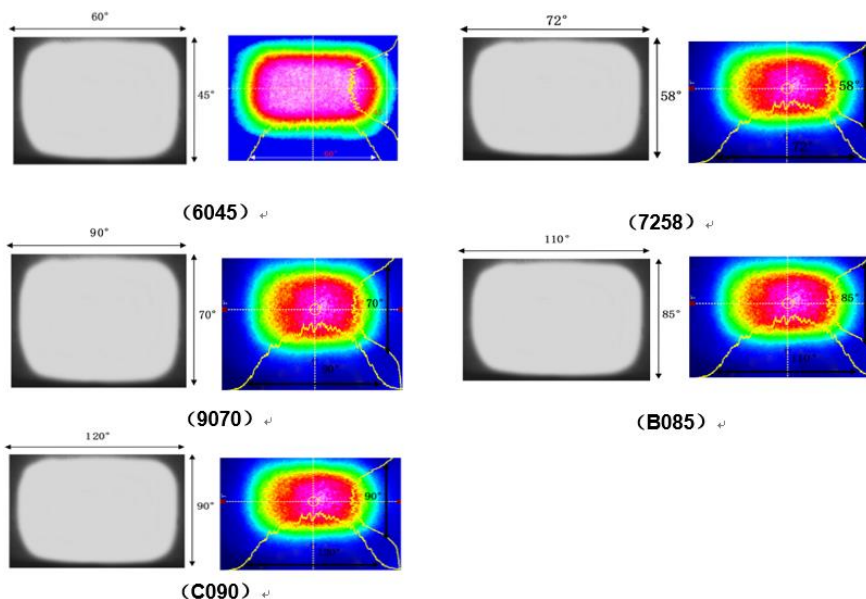

VII. SMT reflow soldering curve

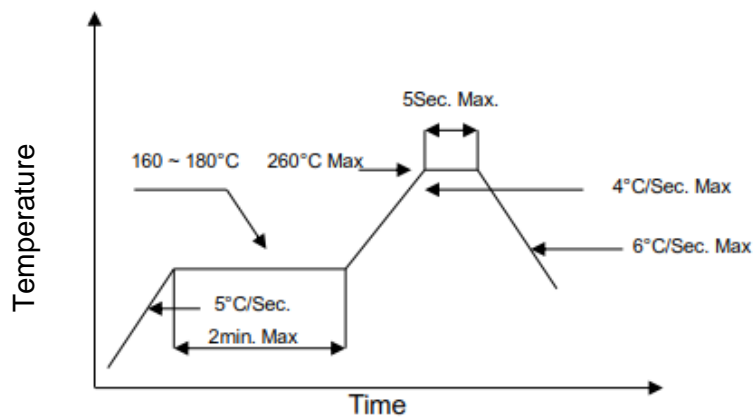

Note: Reflow soldering can be operated only one time. During the temperature ramp-up, no forces may be exerted on the LD which could deform or damage them. After soldering completed, please also do not process until the product temperature ramp down to room temperature.

VIII. Treatment and protection measures

Soldering precautions

The temperature of soldering iron must be controlled under 300°C during manual soldering. Also, VCSEL can be only soldered one time with the soldering time less than 3s. But, It is very hard to control the soldering temperature and homogenize solder paste because of the smaller size of VCSEL. In addition, it is easy to damage VCSEL structure even causes VCSEL losing efficacy. So, we advise you to use re-flow soldering machine for operation.

Storage precautions

Our products were sealed by aluminum foil bag attaching packed desiccant, they are moisture proof and anti-static. Please handle these gently to avoid damage. At the same time, please be ready for storage and take some moisture-proof measures to keep VCSEL away from dampness that may causes reliability failure.

Before opening, VCSEL must be saved for at least 90 days below 30°C with 60% RH.

After opening, VCSEL must be kept in an environment that temperature lower than 30°C and humidity lower than 60% RH and used up within 24 hours. When the storage humidity reaches and exceeds 60%, the products must be dehumidified at 60 °C for more than 24 hours before use.

Others

1. Please use solder paste to cure the laser diode.
2. Please make sure that the heat of VD has been completely conducted to metal shell, to avoid affecting the optical power output.
3. This VD can be only used in constant voltage and current.
4. Operating voltage and current, refer to the table in paragraph II .
5. Please do not aim the laser to people or animal.
6. You can observe the laser spot through an image monitoring equipment.
7. Please do not touch VD surface by naked hands or squeeze the sealant on VD surface, or it may cause wrong optical angle and distorted laser spot, even damage the VD.
8. Please use ceramic suction nozzle to such on the VD, so as to avoid VD sticking to the

nozzle.

9. Please add a 0.02 s blowing action after locating the laser diode to aluminum substrate.

IX. Revision history

Revision	Date	Description
V.01	2020/03/09	The first official edition
V.01	2020/04/03	Update part name